



SMART-WAY
RACEWAY
CONFIGURATION GUIDE

DISCOVER

**SMART-WAY
RACEWAY**



The Smart-Way raceway is a floor and wall-based power and data distribution system designed to fit today's working environments. Our raceway system is simple to configure, ADA-Compliant and adds architectural appeal to any space.

We've set out to engineer a system of parts that can be configured to meet the demands of a changing workplace and workforce. The system provides you with a cost-effective and simple way to get your power, data, and AV across the room to where you really need it.



Redefine how you manage your cables in any space with our raceway, fittings, in-feeds, and device box options. The Smart-Way is intended for offices, conference rooms, collaborative work environments, classrooms, or anywhere wire management is desired.

Smart-Way Capacity

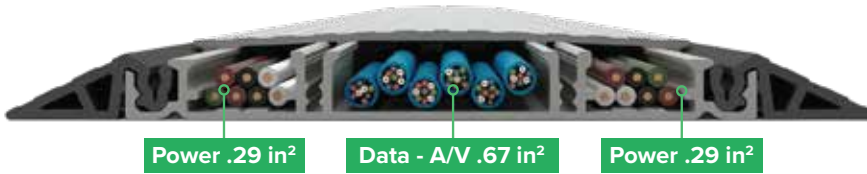

Raceway used for power and data



Raceway used for data only

Systems can have 6 power circuits and 6 to 26 data cables. A data only raceway typically accommodates 10 data cables. Raceways can be paralleled to increase capacity.

Power Channels (Each Side x 2)

Size	40% Fill	Suggested Max
12 AWG	8	7

Data & A/V Cables

Diameter	40% Fill		Suggested Max		T
	Center	Each Side	Center	Each Side	
.215"	7	3	9	3	15
.250"	5	2	6	2	10

Raceway Dimensions

Edging	Height	Width
ON	0.6"	6.23"
IN	0.6"	5.28"
CS	0.6"	4.75"
NO	0.6"	4.5"

Ultra-Low Profile

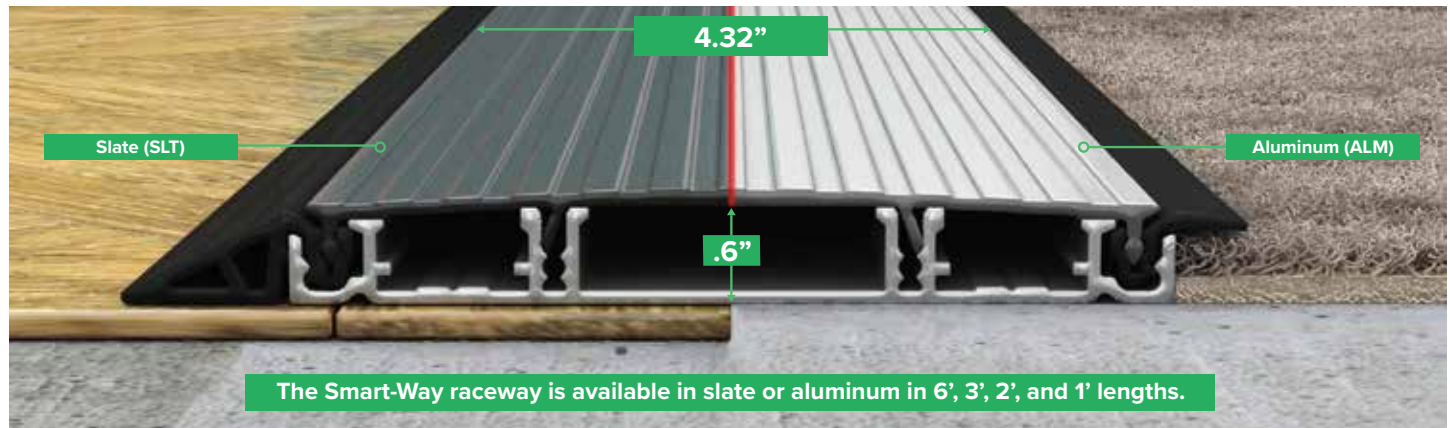

The Smart-Way raceway is available in slate or aluminum in 6', 3', 2', and 1' lengths.

Edging Styles Provided with all Raceway Lengths

ON - On-Floor Edging



IN - In-Floor Edging



Optional Edging Styles and Solutions

NO - No Protruding Features

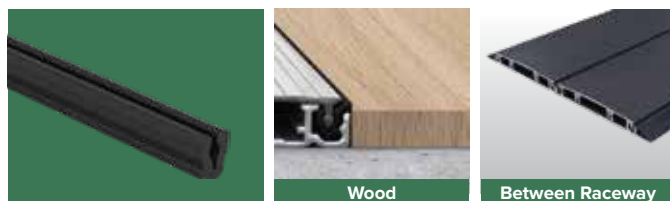

CS - Covered Side for Wall Raceway



FOUR COMPONENTS CREATE A WHOLE SYSTEM

The Smart-Way raceway system can be easily configured to fit your needs. With Smart-Way, four components can get your power and data where needed. The possibilities are endless.



Simple to configure a Smart-Way System

A In-feed

The in-feed component transitions wires and cables from the building into the raceway. We offer many solutions allowing you to feed the raceway from walls, ceiling, and poke thrus. These components are available in slate gray or aluminum. The in-feed options are designed with your architectural aesthetic in mind.

B Raceway

The Smart-Way Raceway includes two edging styles, which allows it to be installed in any flooring situation. The in-floor edging is used to install the raceway in all floors (carpet, wood, tile, laminate), while the on-floor provides an ADA-compliant ramp for vinyl, carpet, and wood floors.

C Device Box

The Smart-Way system device boxes offer the connectivity of power and/or data in a stylish multi-color finish. We have many device box options to choose from to fit your application needs.

D End Stop

The end stop provides a simple method to terminate each endpoint.

ONE RACEWAY, MANY POSSIBILITIES

Single Raceway System Guide

1 Raceway Feed From Ceiling, On-wall, Across Floor

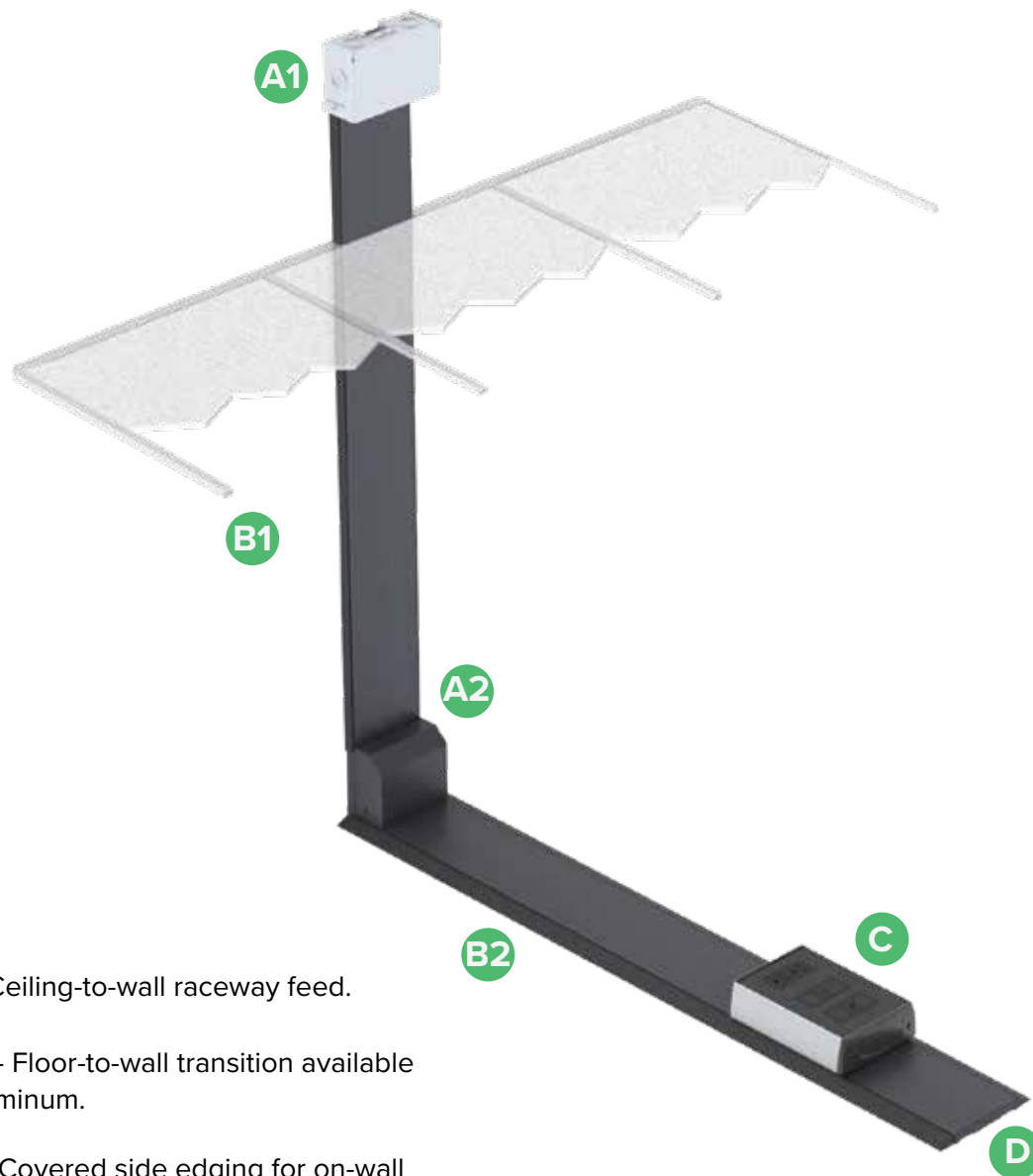

- A1 SW-WT-FC** - Ceiling-to-wall raceway feed.
- A2 SW-WT-SWR** - Floor-to-wall transition available in slate or aluminum.
- B1 SW-TPE-CS** - Covered side edging for on-wall raceway, sold separately. One kit contains 12'.
- B2 SW-Txx** - Raceway length is dependent on spatial requirements, available in aluminum or slate. IN and ON edgings are provided.
- C SW-DB-1P2D** - Shown here is a 3 gang device box with 1 power and 2 low-voltage Decora openings. Any one of Smart-Way's device boxes can be used for this configuration.
- D SW-END-SLT** - Raceway end stop, slate only, and is required at the end of the raceway.

ONE RACEWAY, MANY POSSIBILITIES

Single Raceway System Guide

2 Raceway Feed From Baseboard, Across Floor With Elbow

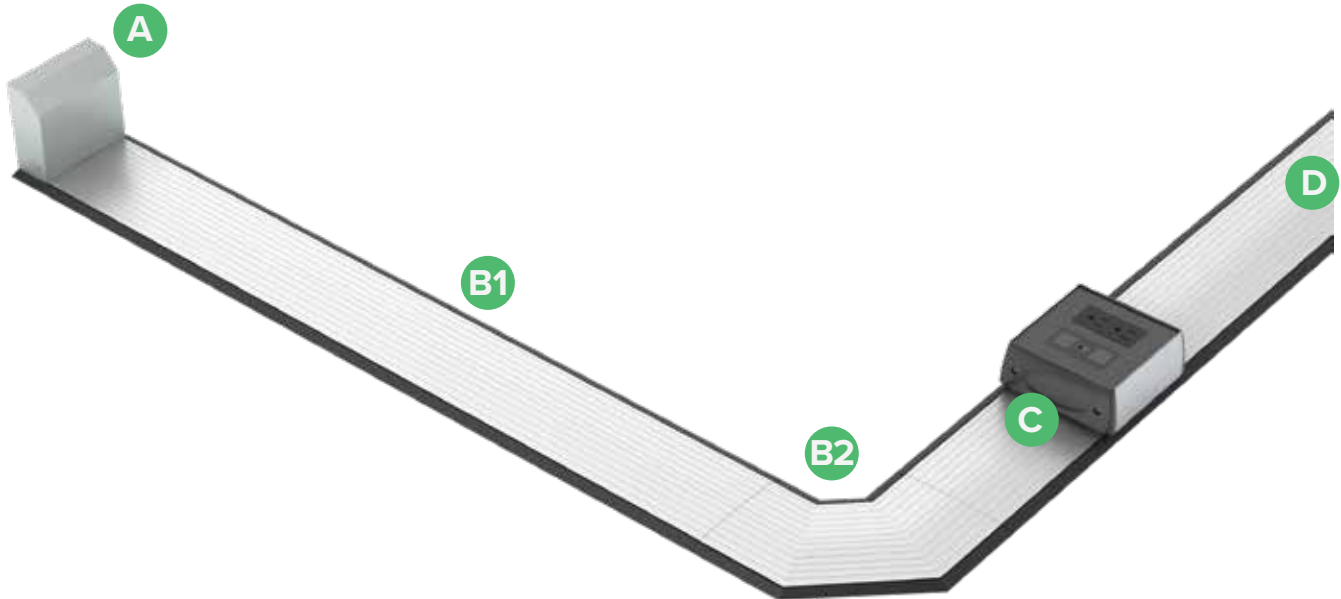

- A SW-WF-LP** - In-feed for 1 or 2 circuits of power and low-voltage feed through.
- B1 SW-Txx** - Raceway length is dependent on spacial requirements, available in aluminum or slate. IN and ON edgings are provided.
- B2 SW-L90** - Corners are available in either 45° or 90°. Choose between aluminum or slate.
- C SW-DB-1P1D** - Shown here is a 2 gang device box with 1 power and 1 low-voltage] Decora openings. Any one of Smart-Way's device boxes can be used for this configuration.
- D SW-END-SLT** - Raceway end stop, slate only, and is required at the end of the raceway.

ONE RACEWAY, MANY POSSIBILITIES

Single Raceway System Guide

3 Raceway Feed From 4" Poke-Thru

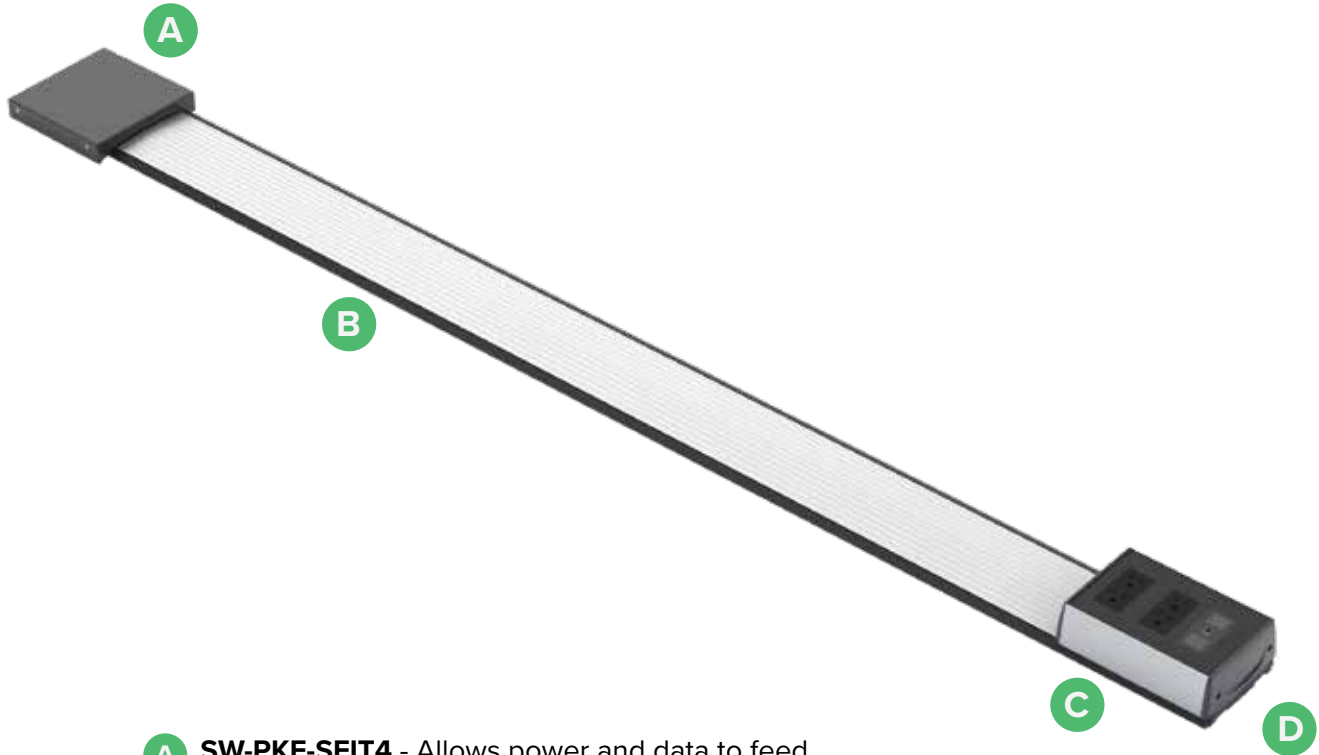

- A** **SW-PKF-SFIT4** - Allows power and data to feed the raceway through a fire-rated concrete floor.
SF-CPT-FF-ALM - 4" Fire-Rated Furniture Feed Poke-T. **NOT SHOWN, ORDERED SEPARATELY.**
- B** **SW-Txx** - Raceway length is dependent on spacial requirements, available in aluminum or slate. IN and ON edgings are provided.
- C** **SW-DB-2P1D** - Shown here is a 3 gang device box with 2 power and 1 low-voltage Decora opening. Any one of Smart-Way's device boxes can be used for this configuration.
- D** **SW-END-SLT** - Raceway end stop, slate only, and is required at the end of the raceway.

ONE RACEWAY, MANY POSSIBILITIES

Single Raceway System Guide

4 Raceway Feed From Wall Outlet With Tee For Multiple Branches



- A SW-WF-RCWY** - A kit containing a Smart-Way in-feed box, Hubbell 1G low-profile box, 1G box cover, flat elbow, & 60" of wall track.
- B1 SW-Txx** - Raceway length is dependent on spacial requirements, available in aluminum or slate. IN and ON edgings are provided.
- B2 SW-TEE** - Two-part tee allowing cables to go in both directions. Both outer power channels are used to deliver AC.
- C1 SW-DB-2D** - Shown here is a 2 gang device box with 2 low-voltage Decora openings. Any one of Smart-Way's device boxes can be used for this configuration.
- C2 SW-DB-2P** - Shown here is a 2 gang device box with 2 power Decora openings. Any one of Smart-Way's device boxes can be used for this configuration.
- D SW-END-SLT** - Raceway end stop, slate only, and is required at the end of the raceway.

MULTIPLE RACEWAYS, LIMITLESS POSSIBILITIES

Paralleled Raceway System Guide

5

Power Feed From Wall Outlet, Data Runs Inside Wall to Both Raceways, Up to 4 Power Circuits and 16 Data Runs

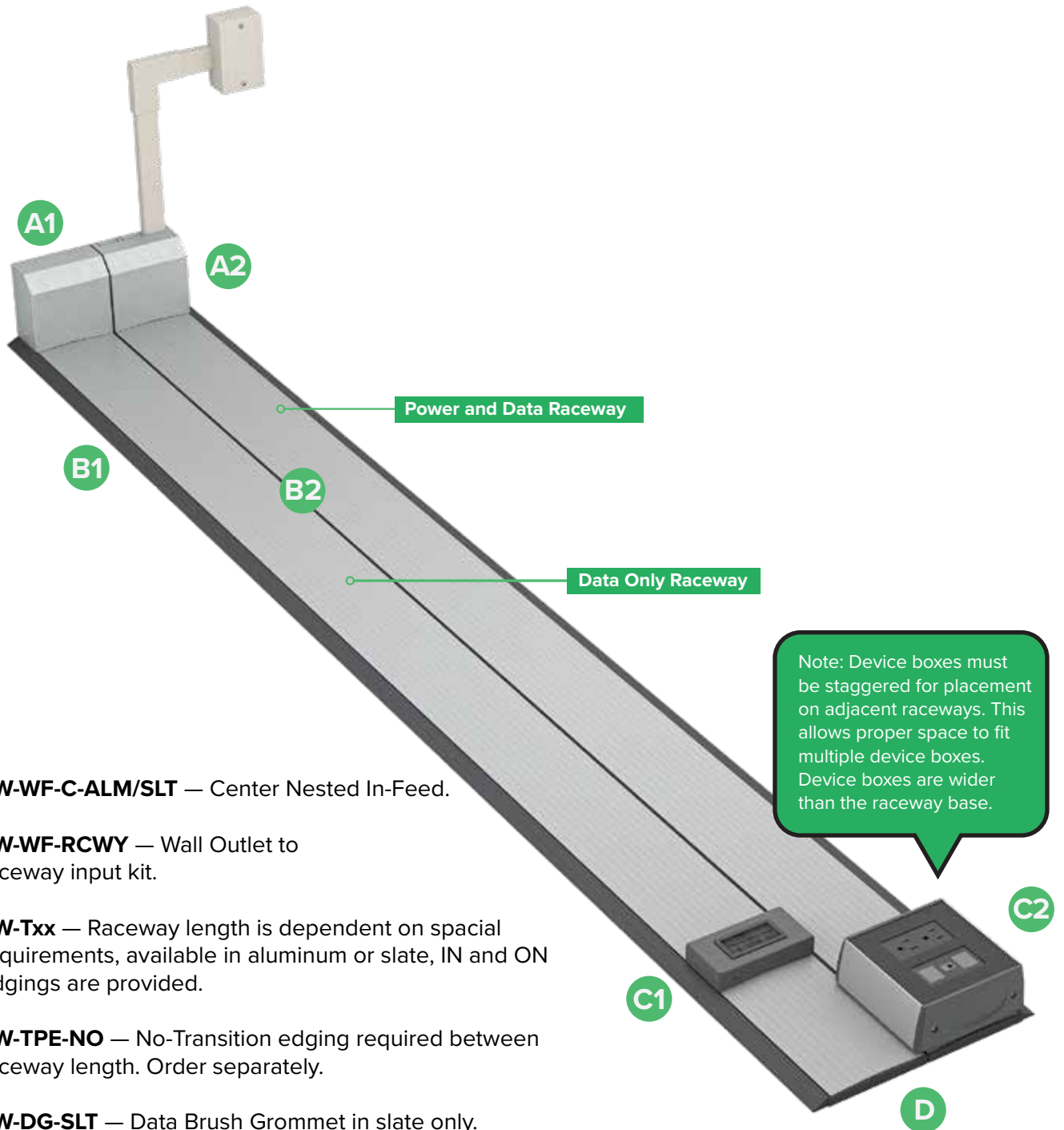

A1 SW-WF-C-ALM/SLT — Center Nested In-Feed.

A2 SW-WF-RCWY — Wall Outlet to raceway input kit.

B1 SW-Txx — Raceway length is dependent on spacial requirements, available in aluminum or slate, IN and ON edgings are provided.

B2 SW-TPE-NO — No-Transition edging required between raceway length. Order separately.

C1 SW-DG-SLT — Data Brush Grommet in slate only.

C2 SW-DB-1P1D — Shown here is a 2 gang device box with 1 power and 1 low-voltage Decora openings. Any one of Smart-Way's device boxes can be used for this configuration.

D SW-END-SLT — Required on all runs (2 required).

6 Power to One Raceway, Data to All 3 Raceways, Cabling Through The Wall, Up to 8 Power Circuits and 26 Data Runs

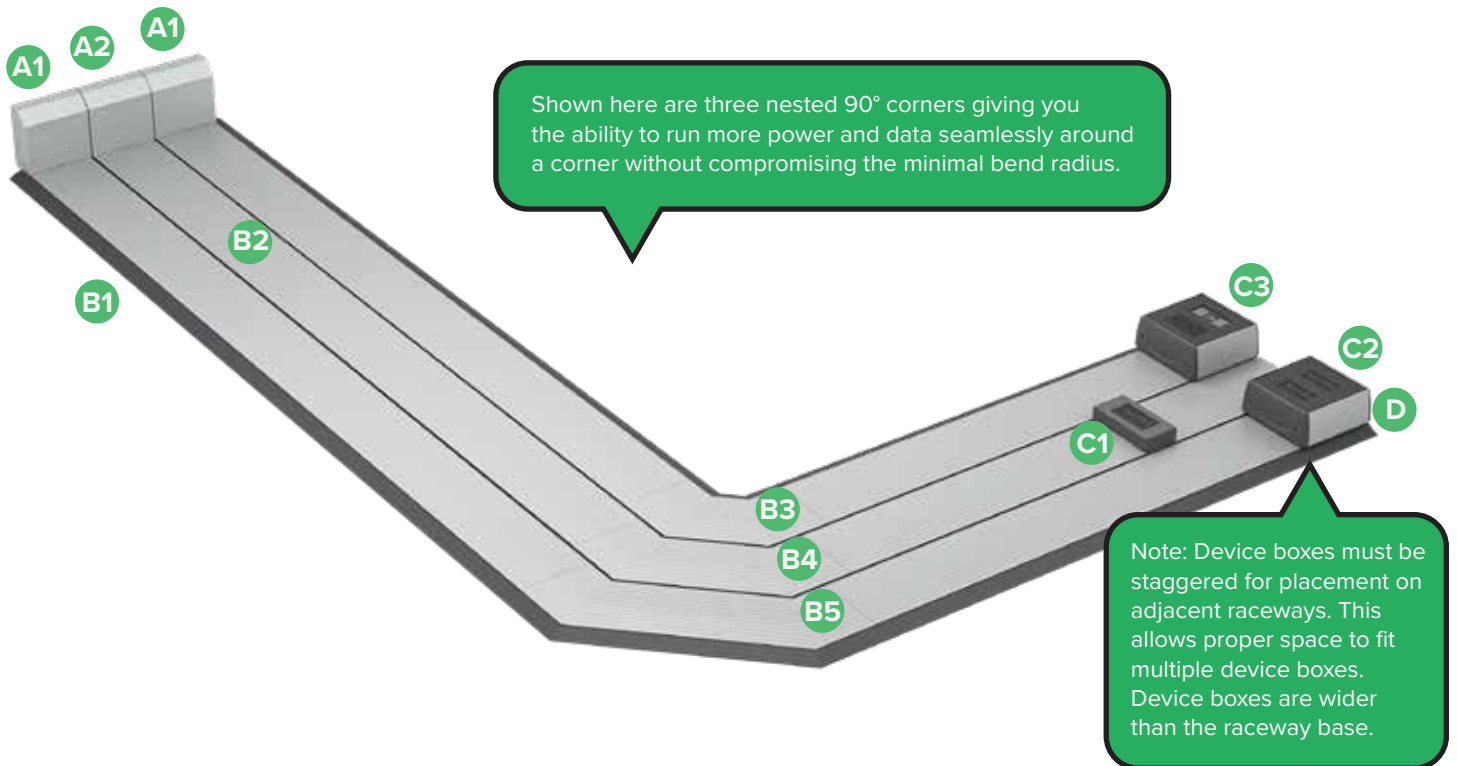

- A1** (2) **SW-WF-HP** – High-profile wall feeds.
- A2** (1) **SW-WF-HP-C** – Center nested in-feed.
- B1** **SW-Txx** – Raceway length is dependent on spacial requirements, available in aluminum or slate, IN and ON edgings are provided.
- B2** **SW-TPE-NO** – No-Transition edging required between raceway length. Order separately.
- B3** **SW-L90** – 1st Elbow.
- B4** **SW-L90-2** – 2nd Elbow for nested 2nd raceway.
- B5** **SW-L90-3** – 3rd Elbow for nested 3rd raceway.
- C1** **SW-DG-SLT** – Data Brush Grommet.
- C2** **SW-DB-2DO** – 2-Gang data only for data in all three channels. Choose from any of our Smart-Way device boxes.
- C3** **SW-DB-1P1D** – Shown here is a 2 gang device box with 1 power and 1 low-voltage Decora openings. Any one of Smart-Way’s device boxes can be used for this configuration.
- D** **SW-END-SLT** – Required on all runs (3 Required).

7 Power to Electrical Box, Data to All 3 Raceways, All Cabling Above Ceiling, Up to 8 Power Circuits and 26 Data Runs

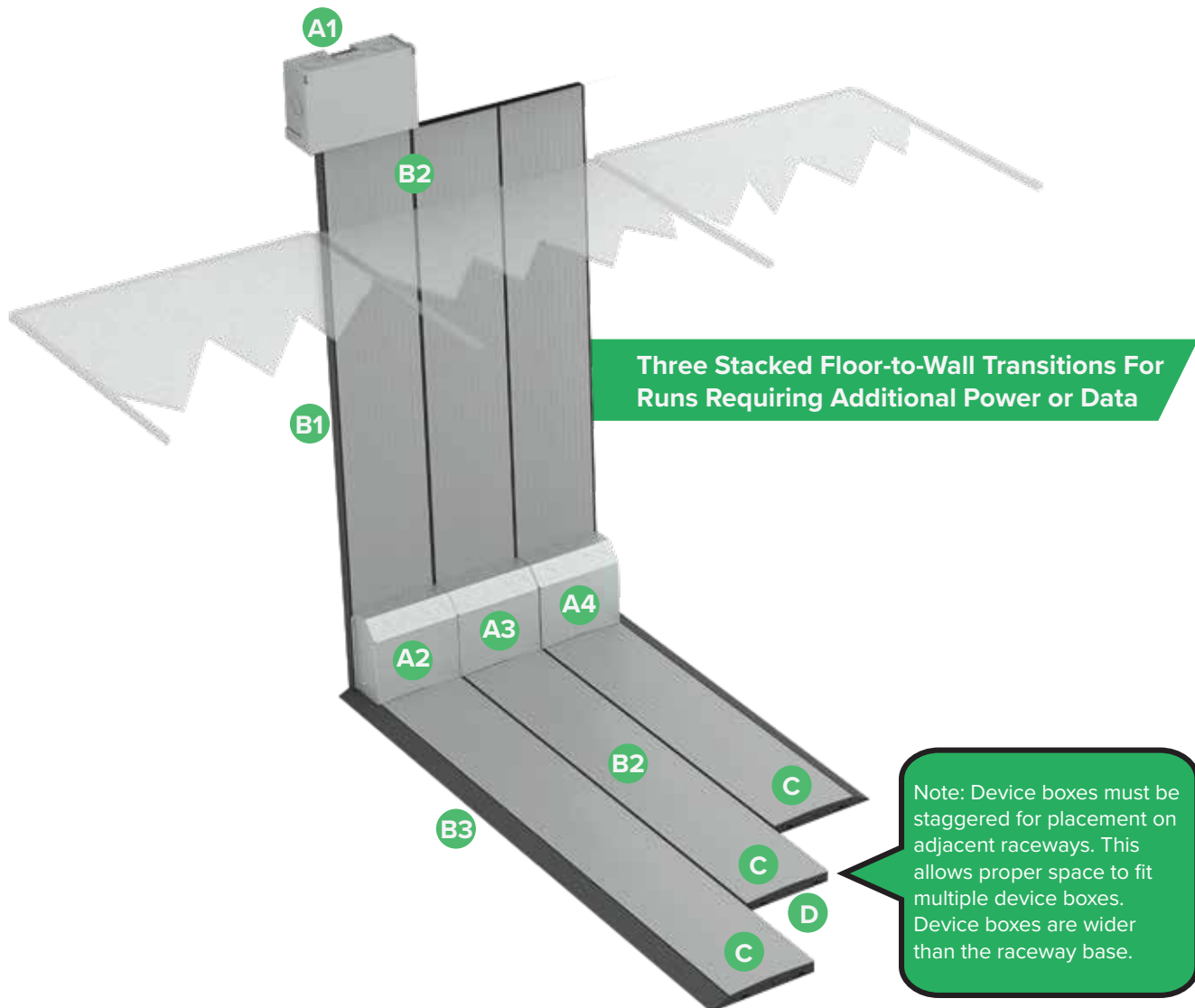

- A1 SW-WT-FC** – Above drop-ceiling raceway feed.
- A2 SW-WT-SWR-L** – Floor-to-wall left side nested Floor-to-wall.
- A3 SW-WT-SWR-C** – Floor to wall center side nested transition.
- A4 SW-WT-SWR-R** – Floor to wall right side nested transition.
- B1 SW-TPE-CS** – Covered side edges.
- B2 SW-TPE-NO** – No-transition edging required between raceway length. Order separately.
- B3 SW-Txx** – Raceway length is dependent on spacial requirements, available in aluminum or slate, IN and ON edgings are provided.
- C** Insert any device box required.
- D SW-END-SLT** – Required on all runs (3 Required).

Baseboard Entry

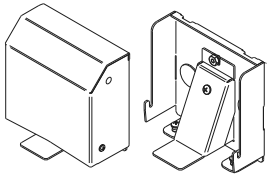

SW-WF-HP-ALM/SLT

High-profile in-feed for power and low-voltage feed through.

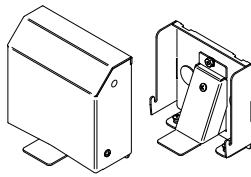

SW-WF-LP-ALM/SLT

Low-profile in-feed for 1 or 2 circuits of power and low-voltage feed through.

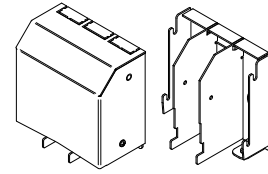

SW-WF-RCWY-ALM/SLT

Wall in-feed kit containing:
 (1) High Profile In-Feed
 (1) Hubbell 1G low-profile box
 (1) Hubbell Flat Elbow
 (1) Hubbell 60" Wall Track

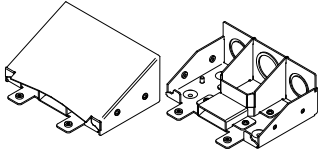

SW-WF-WLP-SLT

Wall feed for metal stud only, with 1 or 2 circuits of power per channel and low voltage.

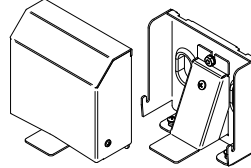

SW-WF-RINLP-ALM/SLT

On-wall feed with cover. Use with SW-WF-RIN in-wall rough-in feed to pass wires through and into the raceway.

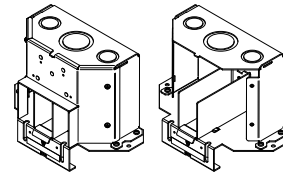

SW-WF-RIN

In-wall rough in-feed with construction cover. Use with SW-RINLP.

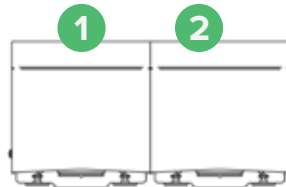
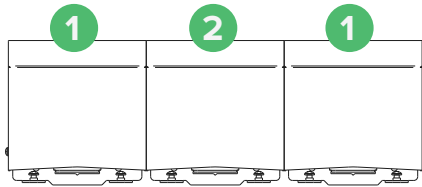

Stacked In-Feeds

- 1 SW-WF-HP-ALM/SLT High-profile in-feed
- 2 SW-WF-HP-C-ALM/SLT Center nested in-feed

Ceiling Entry

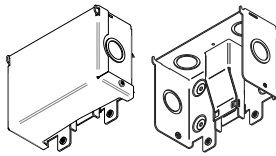

SW-WT-FC

Ceiling to wall raceway feed.

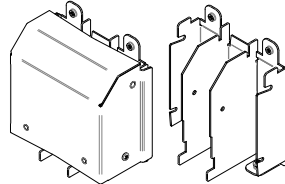

SW-WT-SWR

Floor-to-wall transition. Available in slate and aluminum.

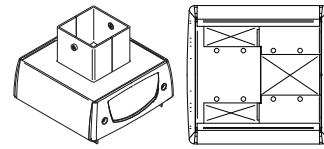

SW-DB-HPP

Power Pole to Smart-Way in-feed. To be used with Hubbell aluminum service pole HBLPP.

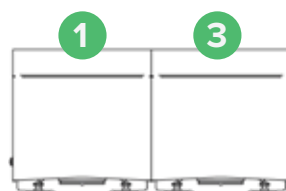
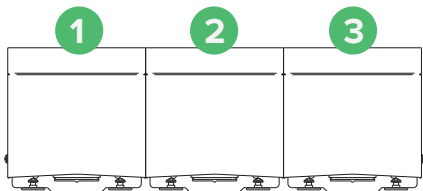

Floor-to-Wall Stacked Transitions

- 1 SW-WT-SWR-L-ALM/SLT Left side nested transition
- 2 SW-WT-SWR-C-ALM/SLT Center nested transition
- 3 SW-WT-SWR-R-ALM/SLT Right side nested transition

Poke-Thru Entry

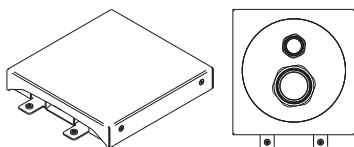

SW-PKF-SFIT4

Poke-Thru to Smart-Way in-feed. Allows power and data to feed the raceway through fire-rated concrete floors.

SF-CPT-FF-ALM

4" Fire-Rated Furniture Feed Poke-Thru ordered separately.

B Raceway & Fittings

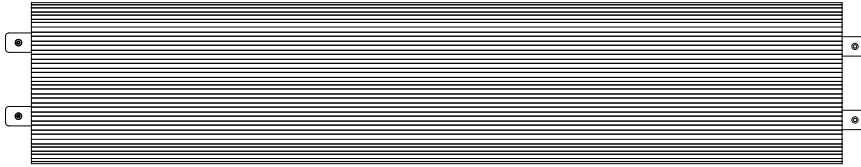

SW-T72-ALM/SLT 72" Raceway Kit
SW-T36-ALM/SLT 36" Raceway Kit
SW-T24-ALM/SLT 24" Raceway Kit
SW-T12-ALM/SLT 12" Raceway Kit
SW-T123-ALM/SLT 1' 2' 3' Saw-less Kit

Raceway sections available in 6', 3', 2', and 1' lengths.

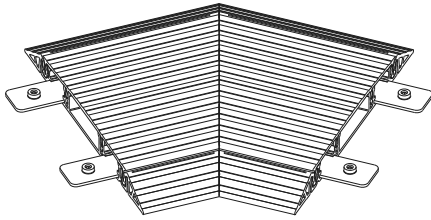

SW-L45-ALM/SLT
45 Degree Corner

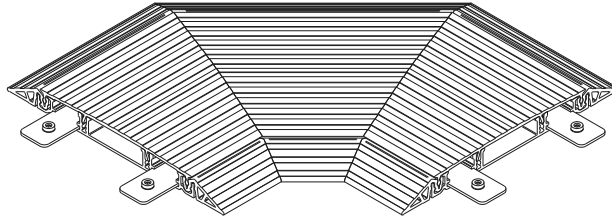

SW-L90-ALM/SLT
90 Degree Corner

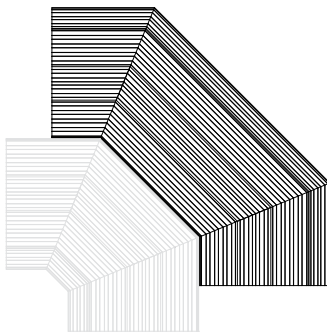

SW-L90-2-ALM/SLT
For nested 2nd
raceway

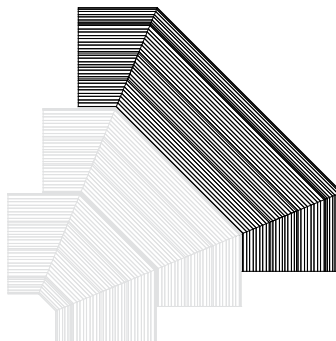

SW-L90-3-ALM/SLT
For nested 3rd
raceway

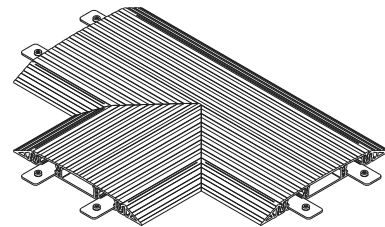

SW-TEE-ALM/SLT
Two-part tee

All Raceway and Fittings Come With On-Floor and In-Floor Edging.

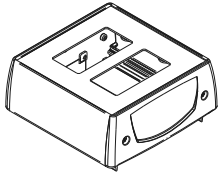

2 gang

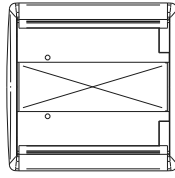

SW-DP-2D
2 Low-voltage
Decora openings

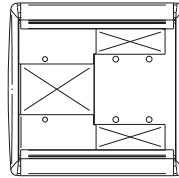

SW-DB-1P1D
1 Power and 1 low-voltage
Decora openings

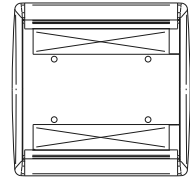

SW-DB-2P
2 Power
Decora openings

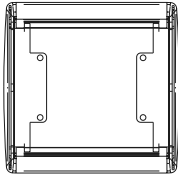

SW-DB-2DO
Use with Data
Raceway Only

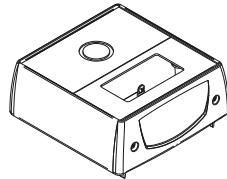

SW-DB-1HWP1D

1 Power and (1-1/2" & 3/4" KO)
1 low-voltage Decora opening

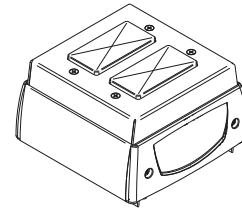
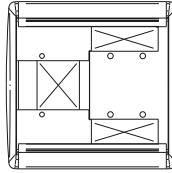

SW-DB-2GEXT
2 Gang
1" extension cover
(Device box not included)

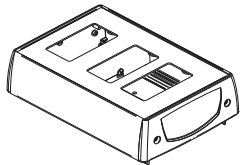

3 gang

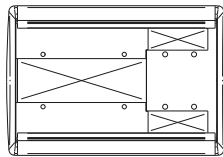

SW-DB-1P2D
1 Power and 2 low-voltage
Decora openings

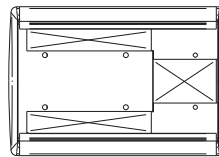

SW-DP-2P1D
2 Power and 1 low-voltage
Decora openings

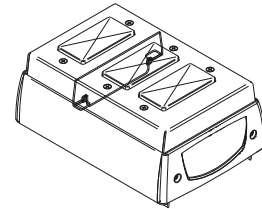

SW-DB-3GEXT
3 Gang
1" extension cover
(Device box not included)

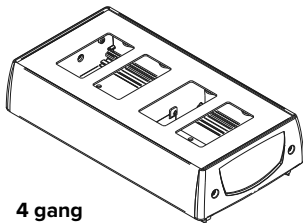

4 gang

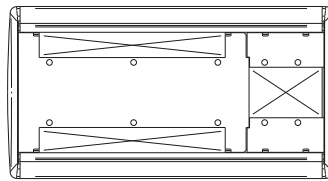

SW-DB-3P1D
3 Power and 1 low-voltage
Decora openings

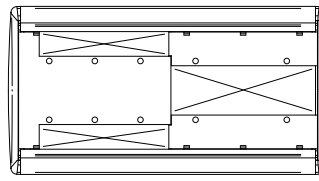

SW-DB-2P2D
2 Power and 2 low-voltage
Decora openings

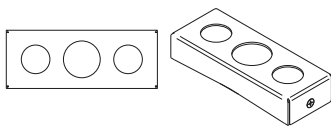

SW-FCT-SLT
Flexible conduit transition
with removable dividers

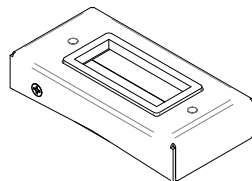

SW-DG-SLT
Data Decora
brush grommet

D End Stop - Required at the end of the raceway

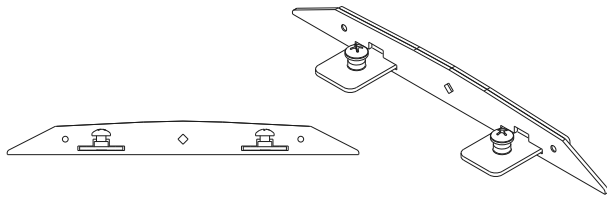

SW-END-SLT
Raceway end stop

Installation Accessories



SW-CVR-TOOL
Cover removal tool



SW-STRC-6
6-pack of extra couplers

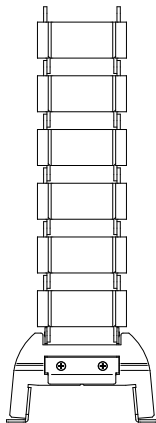

WM-CP-BCKMT-B/S
Cable path from
table to device box.
Available in Black or Silver.

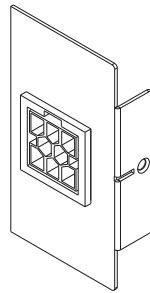

MLS-SW-2SO
1 MLS female connector
in-feed plate
(Requires SW-DB-1HWP1D)

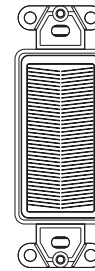

SS-BRSH-BLK
Brush insert
for Decora
opening

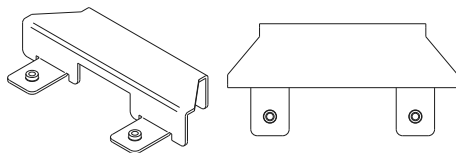

SW-CCEF-SLT
Center channel
end feed

Device Boxes

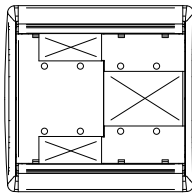
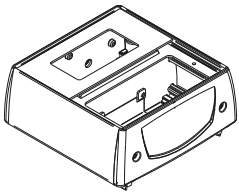

SW-IDB-1P1D
1 Power insert
and 1 Decora opening

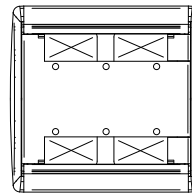
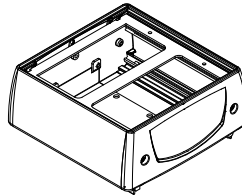

SW-IDB-2P
2 Power insert
openings

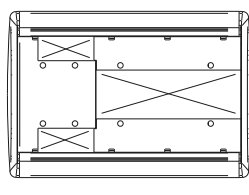
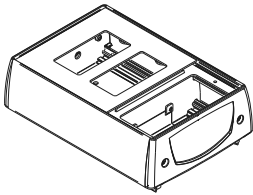

SW-IDB-1P2D
1 Power insert and 2 Decora openings

Socket Mounts

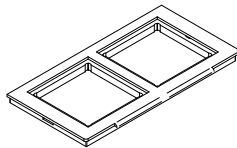
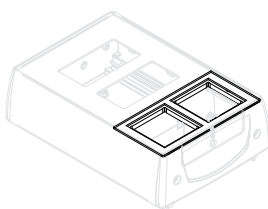
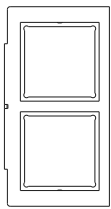

SW-IDB-D45I
Power plate insert w/ 2-45mm openings

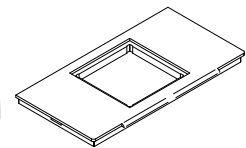
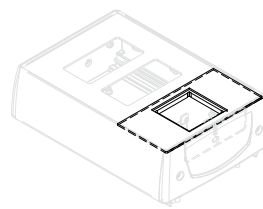
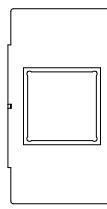

SW-IDB-S45I
Power plate insert w/ 45mm openings

Sockets

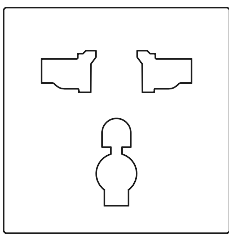

SOC45-UN
45mm
Universal Socket
(10 Amp/250VAC)

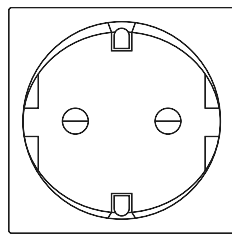

SOC45-TF
45mm
Type F Schuko
Europe and Russia
(16 Amp/250VAC)

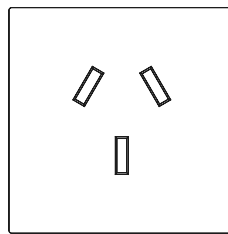

SOC45-TI
45mm Type I
Australia, New Zealand,
China, and Argentina
(10 Amp/250VAC)

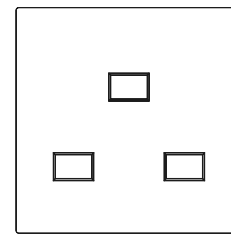

SOC45-TG
45mm Type G
UK, Ireland, Malta,
Malaysia & Singapore
(13 Amp/250VAC)

Pre-wired Smart-Way Stick Options

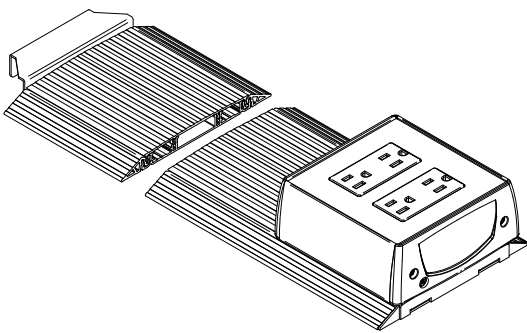
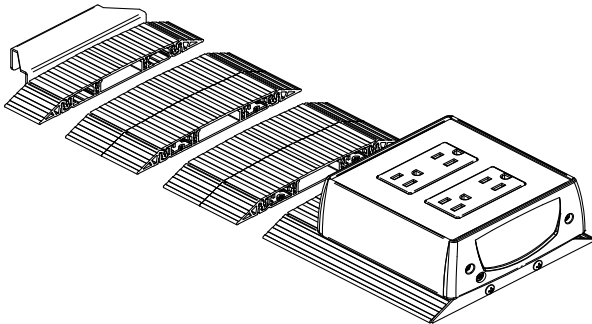
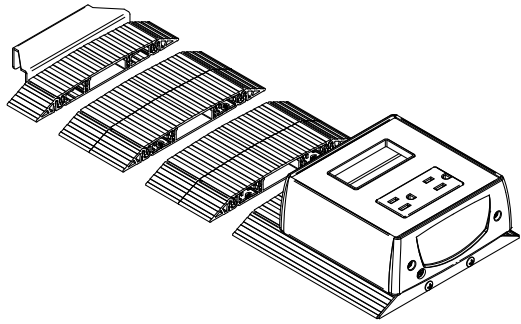

The Smart-Way STICK is the smart way to get power and data on the floor where you need it. The Smart-Way STICK gives you the capabilities for power in a complete wired unit. Place the durable aluminum or slate S TICK on top of any floor surface and plug the cord into an available outlet. The STICK is portable and can be placed where you need it in the room; plug it in, and you're all set.

321 STICK Ordering Table

SW-321STK-1PID-ALM or SLT	3' - 6' Snap Stick with 1 Duplex Power and 1 Data Passage
SW-321STK-2P-ALM or SLT	3' - 6' Snap Stick with 2 Duplex Power
SW-321STK-1PID15-ALM or SLT	Stick 2 Gang 1 Power 1 Data (3' to 6' Plus) 15' Cord
SW-321STK-2P15-ALM or SLT	Stick 2 Gang 2 Power (3' to 6' Plus) 15' Cord
SW-321STK-2PUSB-ALM or SLT	Stick 2 Gang 2 Power 2 USB 5A "C" and "A" Ports (3' to 6')
SW-321STK-2PUSB15-ALM or SLT	Stick 2 Gang 2 Power 2 USB 5A "C" and "A" Ports (3' to 6' Plus) 15' Cord

The 321 Snap Stick models give the convenience of creating specific raceway lengths in the field, giving you the option to assemble a 3', 4', 5', or 6' long Stick.

SMART-WAY STICK Ordering Table

SW-STK-2P-CCC-2PK	2 Fully Assembled 6' Sticks with 2 Duplex Power, CCC-ALM OR SLT
SW-STK-2P-ALM or SLT Stick	6' Stick 2 Duplex Power
SW-STK-1PID-ALM or SLT	6' Stick Kit with 1 Duplex Power and 1 Data Passage (Some Assembly Required)

Portable Power Anywhere, Anytime



See Smart-Way Stick Data Sheet (LIT1761) for complete details.

★ A PROUD ★

U.S.

MANUFACTURER

40 YEARS

NEW  JERSEY



FSR

www.fsrinc.com



244 Bergen Boulevard, Woodland Park, NJ 07424
Phone: 973.998.2300 · Fax: 973.785.4207
Order Desk: 1-800-332-FSR1
Web: fsrinc.com · E-mail: sales@fsrinc.com
LIT1876